

MaxMotion

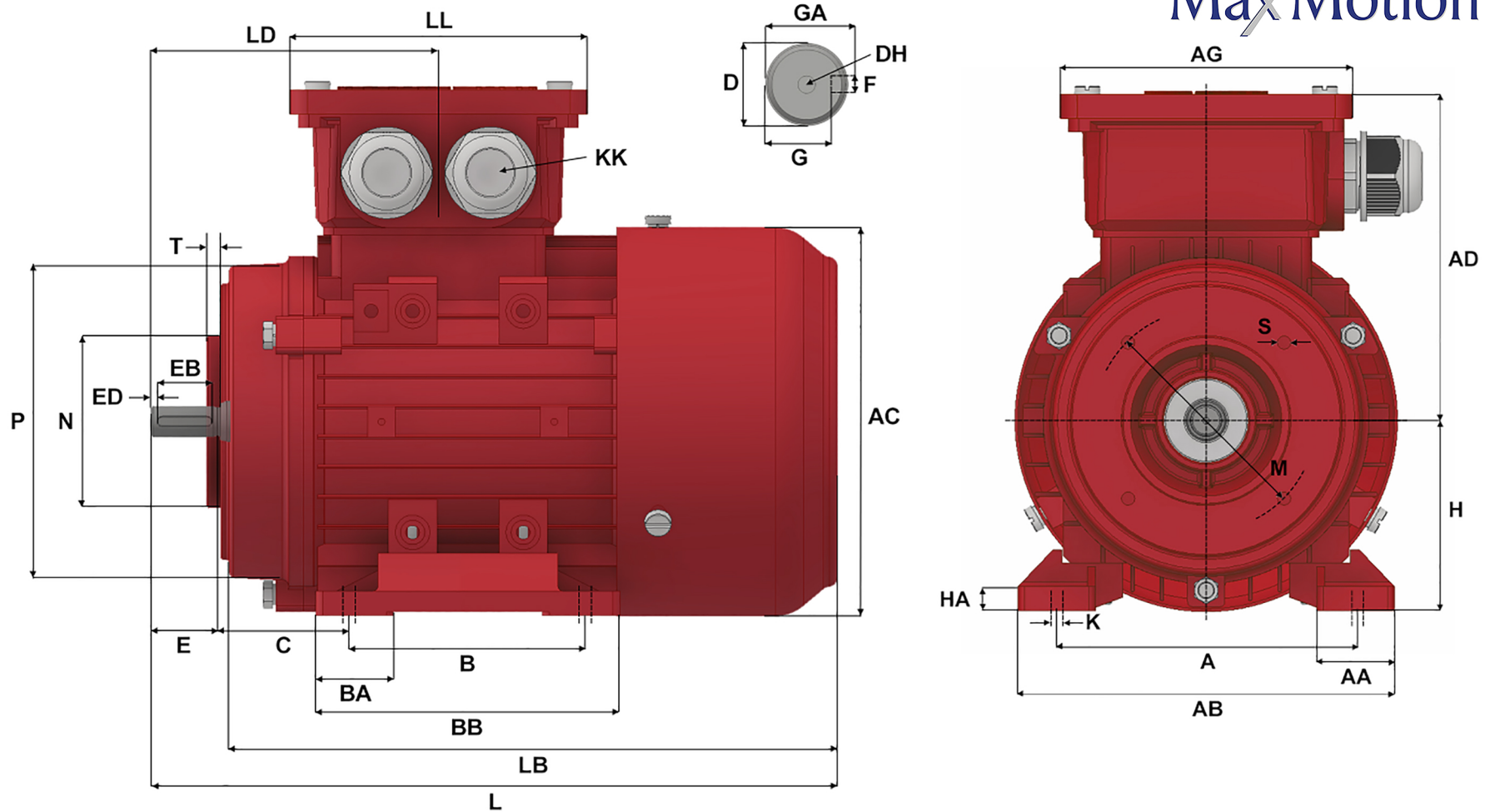

Version: 1JLEM				Revised: 16-02-2023				HP	RPM	FRAME	ENCLOSURE	IJA290S-6-B34A		
Customer is responsible in determining that Max Motion product will fit/perform suitably in the intended application							1	1200	90S	TEFC				
A	B	C	D	E	F	G	H	K	L	M	N	P		
140	100	56	24	50	8	20	90	10 X 14	315	115	95	140		
S	T	AA	AB	AC	AD	AG	BA	BB	DH	EB	ED	GA		
M8	3	37	173	165	138	109	32.5	125	M8 X 19	40	5	27		
HA	KK (1)	KK (2)	KK (3)	LB	LD	LL								
10	M20 X 1.5	3/4" NPT	-	265	136	109								